

Installation

TANDBERG
1500 *MPX*

Unpacking

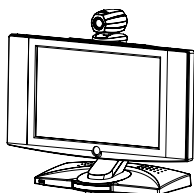

TANDBERG Unit

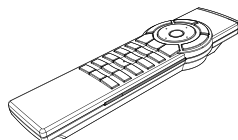

Remote Control

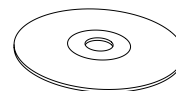

User Manual on CD

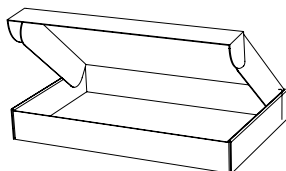

Accessories

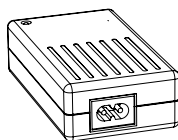

Power Supply

Connecting Cables

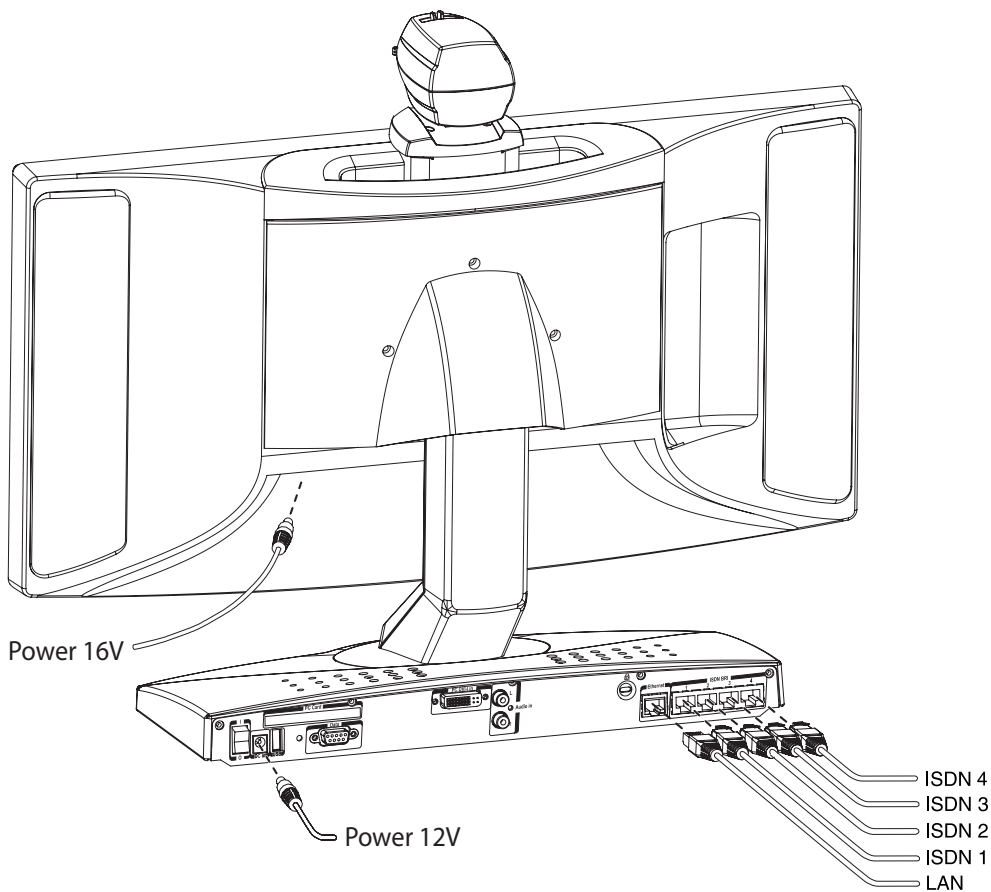

Monitor Configuration

Make sure that your monitor uses your desired language and that surround sound is OFF. To make sure that the monitor goes into power saving mode when not in use, the monitor power saving must be set to on.

1. Monitor language:

- 1) Press the menu key on the monitor to bring up the monitor menu.
- 2) Use arrow key down to select Language. Confirm the with the menu key.
- 3) Use arrow keys to select your desired language. Press menu key to confirm.
- 4) Press the menu key again to exit the monitor menu.

2. Surround sound OFF:

- 1) Press the menu key on the monitor.
- 2) Choose Audio and press the menu key to confirm.
- 3) Choose Surround OFF. Change the setting using the+ and - keys.
- 4) Press the menu key again to exit the menu.

3. How to set power saving to ON:

- 1) Press the menu key on the monitor.
- 2) Choose Audio by pressing arrow down 3 times. Press the menu key to select.
- 3) Choose Power Saving and make sure that it is set to On.
- 4) Press the menu key again to exit the menu.

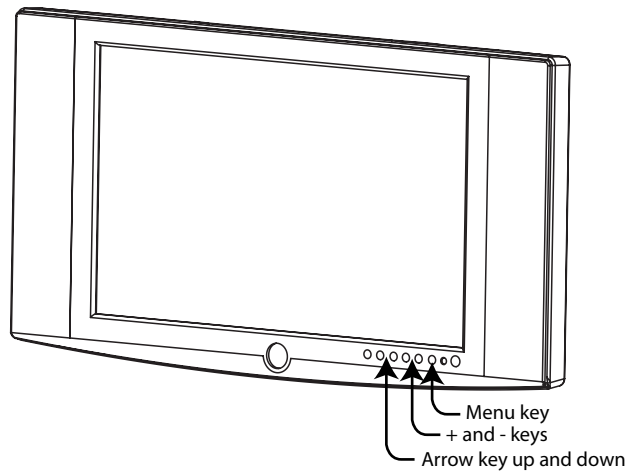

System Configuration

1. Open the Administrator Settings menu

Choose 'Control Panel' from the main menu. In 'Control Panel', select 'Administrator Settings' and press OK.

TIP

If the menu is not already present, press the OK/Menu key on the remote control to open the menu. Navigate the menu with arrow keys and OK.

2. Language

Open 'General'. Select language.

3. ISDN Configuration

Open 'Network - ISDN-BRI Settings'. Make ISDN configuration and press 'Save'.

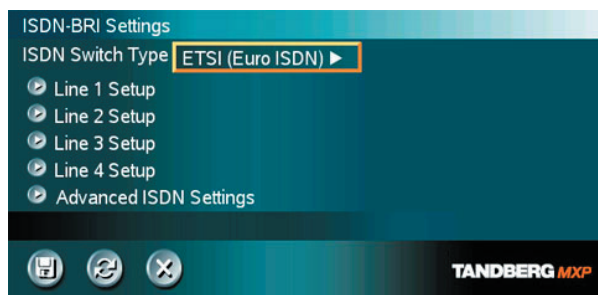

4. LAN Configuration

Open 'Network -LAN Settings'. Make IP/H.323 settings and press 'Save'.

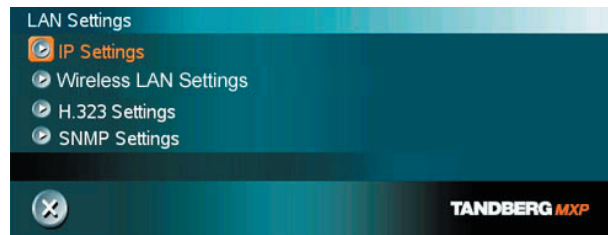

Please read the user manual for further details.